

\* NOTES \* (UNLESS OTHERWISE SPECIFIED)

MECHANICAL

- ① HOUSING : POLYAMIDE(PA), UL94V-0, COLOR BEIGE (NATURE)
- ② CONTACT : PHOSPHOR BRONZE, 0.32x0.35mm  
WITH TIN 80~130μ PLATED OVERALL

SPECIFICATION

- ① CURRENT RATING : 1.5 AMPERE MAX.
- ② VOLTAGE RATING : 125V MAX.
- ③ CONTACT RESISTANCE : 20 MILLIOHM MAX.
- ④ INSULATION RESISTANCE : 500 MEGOHM MIN.
- ⑤ WITHSTANDING VOLTAGE : 500V AC/MINUTE
- ⑥ OPERATING TEMPERATURE : -40°C TO +105°C
- ⑦ WAVE SOLDERING PEAK-TEMP. : 245±5°C FOR 3±0.5 SECONDS
- ⑧ APPLICABLE WIRES : AWG.#28~#32

\*\*\* THIS IS A RoHS-2 RECOGNIZED PRODUCT  
\*\*\* MATES WITH PWB16 SERIES HOUSING AND CRIMP TERMINALS

ORDER OPTION(S)

RWB16-32KP0 \*\* I6

CIRCUIT NUMBER  
FROM 02 TO 16 PINS AVAILABLE

CIRCUIT	ORDER NUMBER	A	B
2	RWB16-32KP00216	4.25	1.25
3	RWB16-32KP00316	5.50	2.50
4	RWB16-32KP00416	6.75	3.75
5	RWB16-32KP00516	8.00	5.00
6	RWB16-32KP00616	9.25	6.25
7	RWB16-32KP00716	10.50	7.50
8	RWB16-32KP00816	11.75	8.75
9	RWB16-32KP00916	13.00	10.00
10	RWB16-32KP01016	14.25	11.25
11	RWB16-32KP01116	15.50	12.50
12	RWB16-32KP01216	16.75	13.75
13	RWB16-32KP01316	18.00	15.00
14	RWB16-32KP01416	19.25	16.25
15	RWB16-32KP01516	20.50	17.50
16	RWB16-32KP01616	21.75	18.75

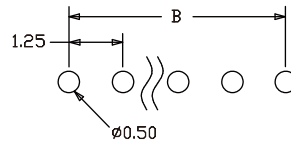
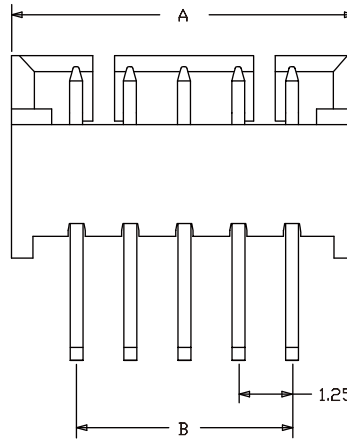
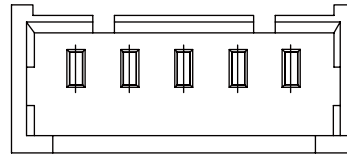

RECOMMENDED P.C.B. LAYOUT  
DIMENSIONS  
(ACCEPTED TOLERANCE ±0.05mm)

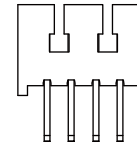

FIGURE OF CKT 4~16  
WITH TWO LOCKS

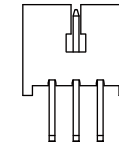
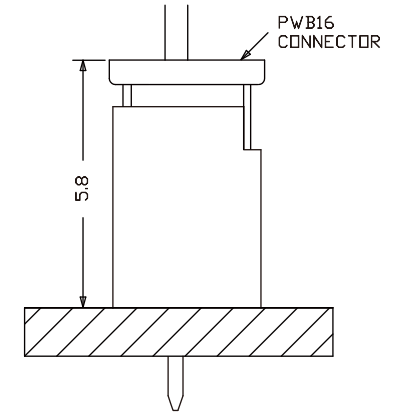
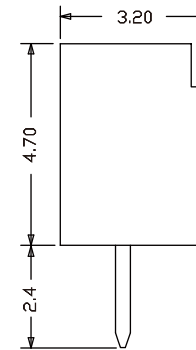

FIGURE OF CKT 2 & 3  
WITH ONE LOCK



MATED CONNECTOR  
FIGURE

METRIC		WIROS ELECTRONICS INTERNATIONAL COMPANY LIMITED	
DRAWER VIVIAN, W		NOTICE OF PROPRIETARY PROPERTY	
APPROVER STAR, H		THIS DRAWING CONTAINS INFORMATION THAT IS PROPRIETARY TO WIROS ELECTRONICS INTERNATIONAL COMPANY LIMITED AND SHOULD NOT BE USED WITHOUT WRITTEN CONSENT FROM WIROS.	
DIMENSIONS ARE IN MILLIMETERS TOLERANCES		TITLE	
X. ----- X.X ±0.30 X.XX ±0.20 X.XXX ±0.10 ANGLES ±3°		1.25 WIRE TO BOARD THRU HOLE WITH LOCK VERTICLE CONNECTOR	
DO NOT SCALE DRAWINGS		PRODUCT NUMBER	
THIRD ANGLE PROJECTION		RWB16-32KP0**I6	
SIZE A4	REV.	SCALE NONE	SHEET 1 OF 1